

hematec SMART-HMI-VA-17X0 17 (P) Dimensions

Unit: mm
Tolerance: +/- 0.5
Rev: 1.0
Date: March/22th 2021

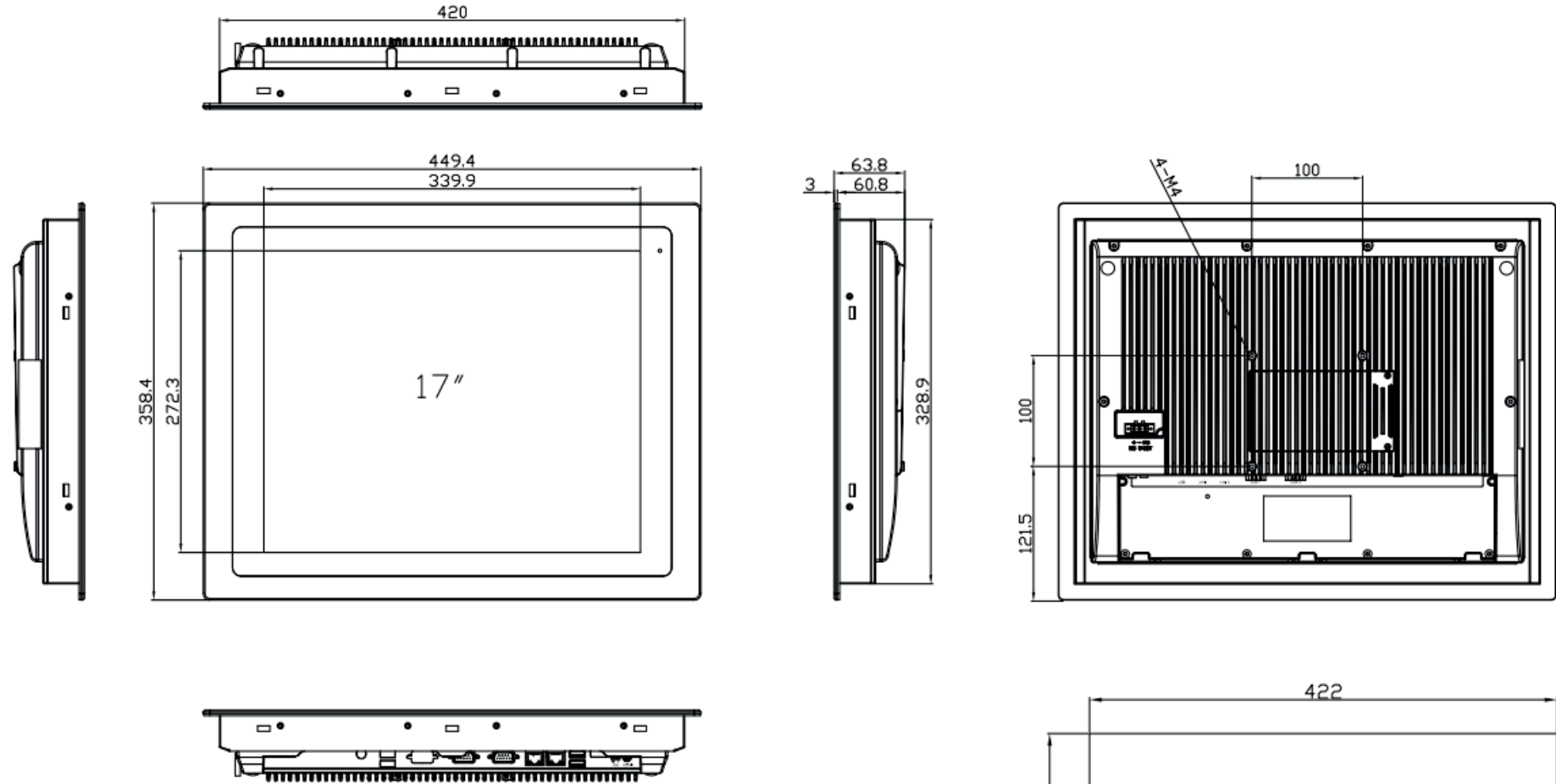

UNIT: mm
Tolerance: ±0.5

